

Goodmans

XB4CDGX
CD Karaoke
User Guide

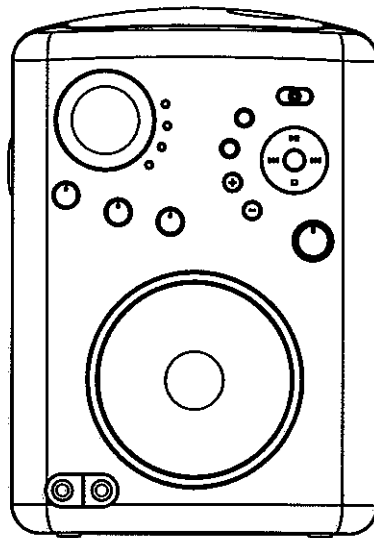

IMPORTANT: Please read all instructions carefully before use and keep for future reference

Introduction

Thank you for choosing this Goodmans CD Karaoke.

Your CD Karaoke will provide you with fun and entertainment. It can let you be the "star" while singing with your favorite recordings and also display the song lyrics on your TV screen.

It's really easy to use; here are a few of the features:

Lyrics on TV screen - displays song lyrics when playing CD+G discs.

Auto Voice Control - lets you replace the original singer's voice with your own voice when playing a karaoke CD.

Balance Control - lets you adjust the balance between the prerecorded original singer's voice and the music when playing a karaoke CD.

Echo Control - lets you add an echo effect to your voice.

Auxiliary Input - lets you connect an auxiliary device such as an MP3 player so you sing along to your favourite tracks.

Safety is important

Use of any electrical equipment should be undertaken with care. Please read the safety section on page 10-12 before using your CD Karaoke. This appliance is for household use only.

What's in the box?

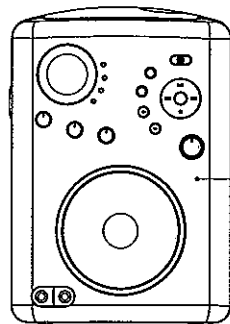

CD Karaoke



This User Guide

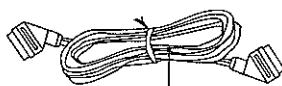

Scart Cable

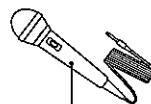

Microphone

Contents

Introduction.....	1
What's in the box.....	2
01 Your CD Karaoke.....	3
02 Making Connections.....	4
03 CD or CD+G Operation.....	5
04 Additional Features.....	7
05 Troubleshooting.....	8
05 Specifications.....	9
07 Warnings.....	10
08 Guarantee.....	13

01 Your CD Karaoke

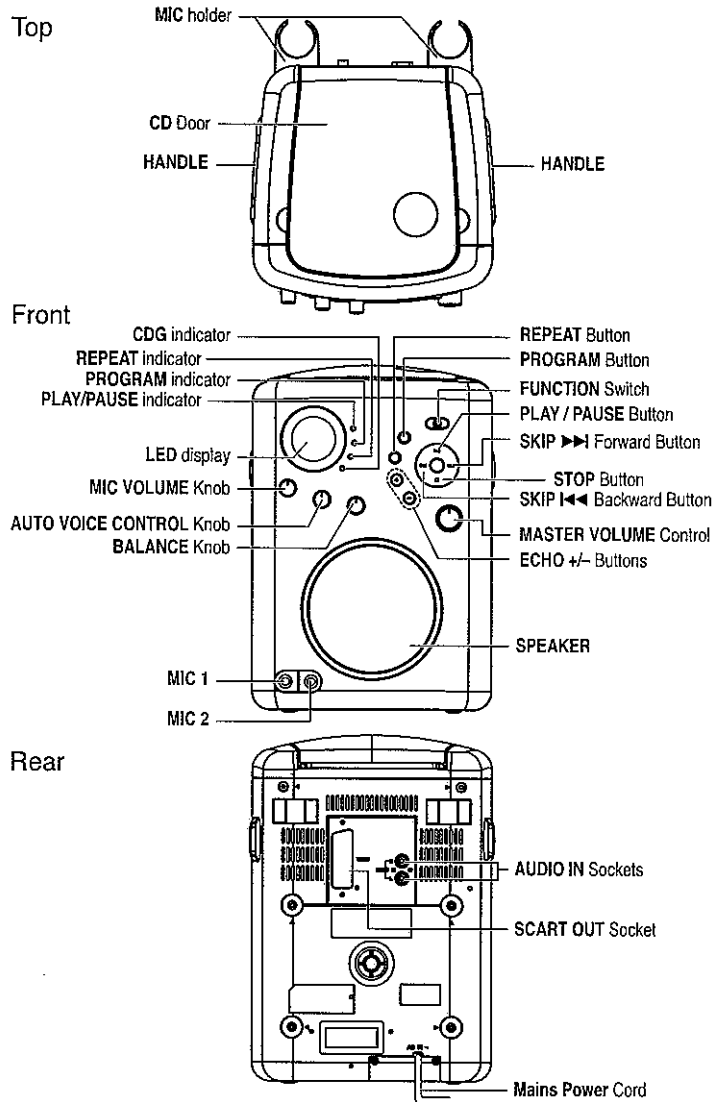

Making Connections

02

CONNECTING POWER

Connect the 3 pin plug to a suitable mains wall outlet.

VIDEO CONNECTION

Please follow the steps below to display CDG lyrics on the TV screen:

- 1 Locate the scart cable.
- 2 Connect the scart cable to the SCART OUT socket of the back of the CD Karaoke.
- 3 Connect the other end of the scart cable to the SCART IN socket on your TV or VCR.

DON'T FORGET!

The sound from the CD Karaoke will also be heard through the speakers on the TV set.

It is recommended not to have the volume of the TV set too high when using the CD Karaoke.

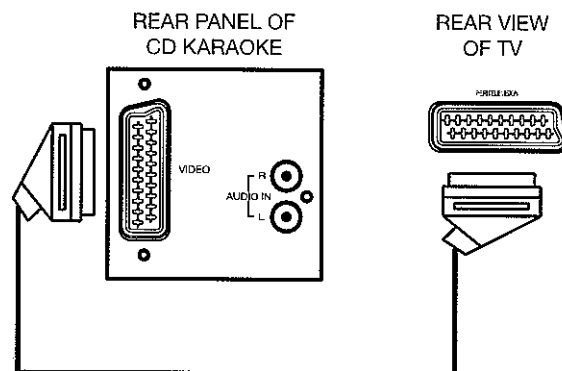

DON'T FORGET!

When connecting the CD Karaoke to your TV set, you must specify the correct input on your TV.

This is usually shown on the TV remote control as "AV", "INPUT", "AUX" or "EXT" etc.

If you have difficulty in seeing the song lyrics from the Karaoke CD after connecting to your TV set, please consult the user guide for your TV, or alternatively contact our customer helpline on 0871 230 1777 for advice.

03 CD and CD+G Operation

Handling CDs

To remove a disc from its storage case, press down on the centre of the case and lift the disc out, holding it carefully by the edges.

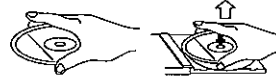

Fingerprints and dust should be carefully wiped off the disc's recorded surface with a soft cloth before use.

DON'T FORGET!

Never use chemicals such as record sprays, antistatic sprays, benzene, or thinners to clean compact discs. These chemicals can damage the disc's surface.

Switching On

- 1 Slide the **FUNCTION** switch to the CD or AUX position.
- 2 To turn the CD Karaoke off, Slide the **FUNCTION** switch to the OFF position.

Adjusting the Volume

- 1 Rotate the **MASTER VOLUME** control to adjust the volume to a comfortable level.

Playing a CD or CD+G Disc

- 1 Slide the **FUNCTION** switch to the CD position.
- 2 Lift up the CD door and carefully place a CD or CD+G onto the central spindle.

DON'T FORGET!

Place the CD label side upwards

- 3 Close the CD door. After a few seconds the display will show the total number of tracks on the disc.

DON'T FORGET!

If no CD, or a scratched or dirty CD is loaded, the display will show "NO".

CD and CD+G Operation

03

Playing/Pausing a track

- 1 Press the **PLAY/PAUSE** button to begin playback of the first track. The Play/Pause indicator will light.
- 2 To pause playback, press the **PLAY/PAUSE** button. The Play/Pause indicator will flash.
- 3 To resume playback, press the **PLAY/PAUSE** button again.
- 4 To stop playback of the CD, press the **STOP** button. The total number of tracks will be shown in the display.

DON'T FORGET!

If you are playing a CD+G disc, the song lyrics will be displayed when you connect the CD Karaoke to your TV set with the supplied scart lead.

Skipping Tracks

- 1 During playback, press the **SKIP I-◀◀ / ▶▶ I** buttons to skip to the next or previous track.

Searching tracks (audio CD only)

- 1 During playback, press and hold the **SKIP I-◀◀ / ▶▶ I** buttons to search forwards or backwards through the current track.
- 2 To resume playback, release the **SKIP I-◀◀ / ▶▶ I** buttons.

Repeating Tracks

- 1 During playback, to repeat the current track, press the **REPEAT** button once. The Repeat indicator will flash.
- 2 To repeat all tracks on the disc, press the **REPEAT** button twice. The Repeat indicator will stay lit.
- 3 To cancel the Repeat function, press the **REPEAT** button again. The Repeat indicator will turn off.

Programming Tracks

- 1 In **STOP** mode, press the **PROGRAM** button. The Program indicator will flash and "0" will show in the display.
- 2 Use the **SKIP I-◀◀ / ▶▶ I** buttons to select the first track you wish to program.
- 3 Press the **PROGRAM** button to enter this into the memory.
- 4 Repeat steps 2 and 3 until all the desired tracks are programmed into the memory.

DON'T FORGET!

A maximum of 20 tracks can be programmed into the memory.

- 5 To begin playback of the programmed tracks, press the **PLAY/PAUSE** button.
- 6 To clear the programmed tracks, press the **STOP** button twice.

04 Additional Features

Auto Voice Control

To replace the original singer's voice with your own when a pre-recorded multiplex karaoke disc is used:

- 1 Rotate the **Mic VOLUME** to the desired level.
- 2 Rotate the **AUTO VOICE CONTROL** to achieve a balance between playback and microphone volume levels.

DON'T FORGET!

When the **AUTO VOICE CONTROL** is selected, the pre-recorded singer's voice on the karaoke CD will mute when you start to sing into the microphone.

Balance Control

To adjust the **balance** between the original singer's voice and the music when a pre-recorded multiplex karaoke disc is used:

- 1 Turn the **BALANCE CONTROL** between music and vocal to achieve the desired effect.

Echo Control

- 1 In stop mode or playback mode, press the **ECHO +** or **-** buttons to increase or decrease the echo effect.
The echo effect value will show in the display.

DON'T FORGET!

There are 8 levels of echo effect available

- 2 When the desired echo level is reached, the display will return to the current track number after a few seconds.

Auxiliary In Sockets

You can connect an auxiliary device to the CD Karaoke in the following way:

- 1 Connect an RCA/Phono type lead to the **AUDIO IN sockets** on the rear of the CD Karaoke.
- 2 Connect the other end to your auxiliary device.
- 3 Slide the **FUNCTION** switch to the **AUX** position.
- 4 Turn on the auxiliary device and play the content in the usual way. The sound will be heard through the CD Karaoke's speaker.

Troubleshooting

05

Problem	Possible Cause	Solution
No power.	No power plug connection at the AC outlet.	Insert the power plug into the AC outlet.
No sound.	Volume control is set to minimum. The wrong function is selected.	Turn up the volume. Select the correct function.
CD not reading correctly, -- --, "E" or "00" are displayed.	Disc is inserted upside down. Disc is dirty. Disc is scratched. A nonstandard disc is inserted. Moisture has formed inside on the CD lens.	Insert disc correctly. Wipe clean with soft cloth. Use a new disc. Only use discs bearing standard logo  . Wait about 20 to 30 minutes to let it dry out.
No sound - if audio is going through TV or VCR.	Source Selection on TV or VCR is not correct.	Follow directions of "Video Connection".
No song lyrics appear on screen.	Scart lead is not connected properly to the TV. Source selector on TV is not set to AV input.	Connect the scart cable to the SCART socket and to the TV SCART IN. Select the AV input on your TV.

Need extra help?

Don't worry we are just at the other end of the phone. If you are experiencing problems using your new product, before returning it to the retailer, just call 0871 230 1777.

Need a spare parts?

In the unlikely event of you needing spare parts, please contact our spares department on: 0871 230 0790

06 Specifications

Model Number	• XB4CDGX
Power source	• AC 230V ~ 50Hz
Power consumption	• 18W
Frequency response	• 100 – 18,000 Hz
Power Output	• 5W
Speaker	• 3" 4 ohms
Microphone	• -74 dB 600ohms impedance with ø6.3mm dynamic microphone
Unit dimensions	• 192 (D) x 199.3 (W) x 281.2 (H) mm
Unit weight	• approx. 2.5 kgs

IMPORTANT: Due to continual revision and improvements to our products design, specifications are subject to change without notice.

Warnings

07



CAUTION : TO REDUCE THE RISK OF ELECTRIC SHOCK, DO NOT REMOVE COVER (OR BACK). NO USER-SERVICEABLE PARTS INSIDE, REFER SERVICING TO QUALIFIED SERVICE PERSONNEL.



The lightning flash with arrowhead symbol, within an equilateral triangle, is intended to alert the user to the presence of uninsulated "dangerous voltage" within the product's enclosure that may be of sufficient magnitude to constitute a risk of electric shock to persons.



The exclamation point within an equilateral triangle is intended to alert the user to presence of important operating and maintenance (servicing) instructions in the literature accompanying the appliance.



DANGER
INVISIBLE LASER RADIATION WHEN OPEN AND INTERLOCK FAILED OR DEFEATED. AVOID DIRECT EXPOSURE TO LASER BEAM.

LASER SAFETY

This unit employs an optical laser beam system in the CD mechanism, designed with built-in safeguards. Do not attempt to disassemble, refer to qualified service personnel. Exposure to this invisible laser light beam may be harmful to the human eye.

THIS IS A CLASS-1 LASER PRODUCT. USE OF CONTROLS, OR ADJUSTMENTS OR PROCEDURES OTHER THAN THOSE SPECIFIED HEREIN, MAY RESULT IN HAZARDOUS LASER LIGHT BEAM EXPOSURE.

WARNING

To prevent fire or shock hazard, do not expose this appliance to rain or moisture.

The apparatus should not be exposed to dripping or splashing and no objects filled with liquids, such as vases, shall be placed on the apparatus.

The ventilation should not be impeded by covering the ventilation openings with items, such as newspapers, table-cloths, curtains, etc.

No naked flame sources, such as lighted candles, should be placed on the apparatus.

The mains plug is used as the disconnect device, the disconnect device should remain readily operable.

In order to disconnect the apparatus from the mains completely, the mains plug should be disconnected from the mains socket outlet completely.

CAUTION

TO PREVENT ELECTRIC SHOCK, DO NOT USE THIS PLUG WITH ANY EXTENSION CORD, RECEPTACLE OR OTHER OUTLET UNLESS THE PLUG CAN BE FULLY INSERTED WITHOUT EXPOSING ANY PARTS OF THE BLADES.

CLASS 1
LASER PRODUCT

07 Warnings



WEEE

This appliance is labelled in accordance with European Directive 2002/96/EG concerning used electrical and electronic appliances (Waste Electrical and Electronic Equipment - WEEE).

The guideline determines the framework for the return and recycling of used appliances.

Sound levels

Your hearing is very important to you and to us, so please take care when using this Karaoke System. It is strongly recommended that you follow the listed guidelines in order to prevent possible damage or loss of hearing.

Establish a safe sound level

Over time your hearing will adapt to continuous loud sounds and will give the impression that the volume has in fact been reduced. What seems normal to you may in fact be harmful. To guard against this **before your hearing adapts**, set the volume to a low level.

Slowly increase the level until you can hear comfortably and clearly and without distortion.

Damage to your hearing is accumulative and is irreversible. Any ringing or discomfort in the ears indicates that the volume is too loud.

Once you have established a comfortable listening level, **do not increase the sound level.**

General Safety

This Karaoke System has been designed and manufactured to meet European safety standards, but like any electrical equipment, care must be taken if you are to obtain the best results and safety is to be assured.

Do read these operating instructions before you attempt to use the Karaoke System.

Do ensure that all electrical connections (including the mains plug, extension leads and interconnections between pieces of equipment) are properly made in accordance with the manufacturer's instructions.

Switch off and remove the mains plug when making or changing any connections.

Do consult your dealer if you are ever in doubt about the installation, operation or safety of your Karaoke System.

Don't continue to operate the Karaoke System if you are ever in doubt about it working normally, or if it is damaged in any way. Switch it off, withdraw the plug from the mains and consult your dealer.

Don't remove any fixed covers as this may expose you to dangerous voltages.

Don't leave the Karaoke System switched On when it is unattended for long periods of time, unless it is specifically stated that it is designed for unattended operation or has a standby mode.

Make sure that other people in your household are conversant with the Karaoke System.

Don't obstruct the ventilation vents on the Karaoke System, for example with curtains or soft furnishings.

Overheating will cause damage and shorten the life of the product.

Don't allow electrical equipment to be exposed to rain or moisture.

Warnings

07

Electrical Information

This Karaoke System is fitted with a mains lead fitted with a BS1363/A 13amp plug. If it is not suitable for your supply sockets it must be removed and replaced with an appropriate plug.

If the plug becomes damaged and/or needs to be replaced please follow the wiring instructions below.

The plug removed must be disposed of immediately. It must not be plugged into a supply socket as this will be an electrical hazard. If the fuse needs to be replaced it must be of the same rating and ASTA approved to BS1362. If the plug is changed, a fuse of the appropriate rating must be fitted in the plug, adapter or at the distribution board. If the fuse in a moulded plug is replaced, the fuse cover must be refitted before the appliance can be used.

Wiring Instructions

The supply cable will be either 2-core or 3-core.

Follow the appropriate wiring instructions given below. In both cases ensure that the outer sheath of the cable is firmly held by the cable clamp.

2-Core Plug

WARNING! Do not connect either wire to the earth terminal.

This symbol indicates that this 2-core appliance is Class II and does not require an earth connection.

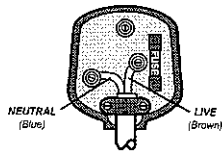

The wire coloured blue must be connected to the terminal marked with the letter N or coloured black.

The wire coloured brown must be connected to the terminal marked with the letter L or coloured red.

3-Core Plug

WARNING! This appliance must be earthed.

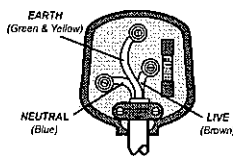

The wire coloured green and yellow must be connected to the terminal marked with the letter E, or by the earth symbol \perp , or coloured green and yellow.

The wire coloured blue must be connected to the terminal marked with the letter N or coloured black.

The wire coloured brown must be connected to the terminal marked with the letter L or coloured red.

08 Guarantee

The Karaoke System is guaranteed for twelve months from the date of original purchase. If there are any defects due to faulty materials or workmanship, contact the Goodmans Helpline. Have your receipt of purchase on hand.

The guarantee is subject to the following provisions:

- It is only valid within the boundaries of the country of purchase.
- The product must be correctly installed and operated in accordance with the instructions contained in this User Guide.
- The Karaoke System must be used solely for domestic purposes.
- The guarantee will be rendered invalid if the Karaoke System is re-sold or has been damaged by inexpert repair.
- The manufacturer disclaims any liability for incidental or consequential damages.
- The guarantee is in addition to, and does not diminish, your statutory or legal rights.

Goodmans
0871 230 1777